

YUKEN

SOLENOID OPERATED DIRECTIONAL VALVES

*-DSG-01-***-* -60/6090
1/8, Sub-plate Mounting

**DIRECTIONAL
CONTROLS**

Up to 31.5 MPa (4570 PSI), 63 L/min (16.6 U.S.GPM)

Mounting Surface : ISO 4401-AB-03-4-A, CETOP-3, NFPA-D01



Terminal Box Type

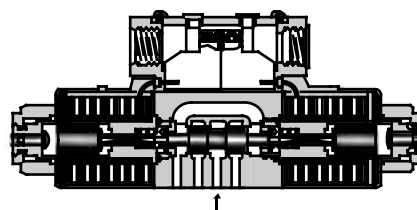

Plug-in Connector Type

■ Features

These are Solenoid Operated Directional Valves of high pressure, high flow and low pressure drop, the features of which can be materialized by employing a powerful wet type solenoid and the rational flow channel design.

- **Standard type.....** Useable at high pressure: 31.5 MPa (4570 PSI) and high flow: 63 L/min. (16.6 U.S.GPM)
- **Shockless type....** A noise at spool changeover and a vibration in piping can be reduced to a minimum.
- **Stable operation**

With a strong magnet and spring force, the valves are tough against contamination and thus ensure a stable operation.

■ Solenoids**● Solenoid Connectors (DIN connector)**

The solenoid connectors conform to the international standard ISO 4400 (Fluid power systems and components-Three-pin electrical plug connectors-Characteristics and requirements).

● AC Solenoids

50 to 60 Hz common service solenoids do not require rewiring when the applied frequency is changed.

● DC Solenoids (Reputable K-series)

These DC solenoids have surge absorbers for K-series functions. The three advantages of them are as mentioned below:

1. Since surge voltage can be controlled to a very low figure, electric control devices, such as a computer, can be used without any interference like noise.
2. There being no spark between contacts, the life of the relay becomes longer.
3. Time lag for spool return after de-energisation of the solenoid is very short.

● R Type Solenoids

These are rectifier and surge absorber incorporated direct current solenoids which can be used by connecting directly to the AC power source. They have, like other DC solenoids, such advantages that the sound in on-off operation is quite low and the coils are hardly burnt out even if the spool is stuck at the halfway of its changeover for contaminant particles etc. Moreover, they can be used almost permanently without being affected by a surge voltage from the outside. Thus, they are the solenoids of high reliability and durability.

● Insulation Class of Solenoid

Class H

The products approved by CSA (Canadian Standards Association) and the products conforming to the Low Voltage Directive 73/23/EEC (amended by 93/68/EEC) are also available. For the details, please consult us or your Yuken distributors.

■ Specifications

Valve Type	Model Numbers	Max. Flow * L/min (U.S.GPM)	Max. Operating Pressure MPa (PSI)	Max. T-Line Back Pres. MPa (PSI)	Max. Changeover Frequency min ⁻¹ (Cycles/Min)	Approx. Mass kg(1bs.)	
						Type of Solenoid	
						AC	DC, R
Standard Type	DSG-01-3C*-60/6090	63 (16.6)	31.5 (4570) {Spool Type 60 Only 25 (3630)}	16 (2320)	300 (R Type Sol. Only) 120	1.9 (4.2)	2.2 (4.9)
	DSG-01-2D2*-60/6090					1.45 (3.2)	1.6 (3.5)
	DSG-01-2B*-60/6090					—	—
Shockless Type	S-DSG-01-3C*-60/6090	40 (10.6)	16 (2320)	16 (2320)	120	—	2.2 (4.9)
	S-DSG-01-2B2*-60/6090					—	1.6 (3.5)

★ The maximum flow means the limited flow without inducing any abnormality to the operation (changeover) of the valve. The maximum flow differs according to the spool type and operating conditions. For details, please refer to the "List of Standard Models and Maximum Flow" on pages 5 to 9.

■ Solenoid Ratings

Valve Type	Electric source	Coil Type	Frequency (Hz)	Voltage (V)		Current & Power at Rated Voltage		
				Source Rating	Serviceable Range	Inrush (A)*2	Holding (A)	Power (W)
Standard Type	AC *1	A100	50	100	80 - 110	2.42	0.51	—
			60	100	90 - 120	2.14	0.37	
				110		2.35	0.44	
			A120	50	120	96 - 132	2.02	
		60		108 - 144		1.78	0.31	
		A200	50	200	160 - 220	1.21	0.25	
			60		200	180 - 240	1.07	
		220		1.18	0.22			
Shockless Type	DC (K Series)	A240	50	240	192 - 264	1.01	0.21	
			60		216 - 288	0.89	0.15	
		D12	—	12	10.8 - 13.2	—	2.45	29
				24	21.6 - 26.4		1.23	
48	43.2 - 52.8			0.61				
AC → DC Rectified (R)	R100	50/60	100	90 - 110	—	0.33	29	
			200	180 - 220		0.16		

★1. AC solenoid is not available in shockless type.

R type models with built-in current rectifier is recommended for shockless operation with AC power.

★2. Inrush current in the above table show rms values at maximum stroke.

★3. There are more coil types other than the above. For details, please make inquiries.

The coil type numbers in the shaded column are handled as optional extras. In case these coils are required to be chosen, please confirm the time of delivery with us before ordering.

■ Sub-plate

Piping Size	Japanese Standard "JIS"		European Design Standard		N.American Design Standard		Approx. Mass kg (lbs.)
	Sub-plate Model Numbers	Thread Size	Sub-plate Model Numbers	Thread Size	Sub-plate Model Numbers	Thread Size	
1/8	DSGM-01-30	Rc 1/8	DSGM-01-3080	1/8 BSP.F	DSGM-01-3090	1/8 NPT	0.8 (1.8)
1/4	DSGM-01X-30	Rc 1/4	DSGM-01X-3080	1/4 BSP.F	DSGM-01X-3090	1/4 NPT	0.8 (1.8)
3/8	DSGM-01Y-30	Rc 3/8	—	—	DSGM-01Y-3090	3/8 NPT	0.8 (1.8)

● Sub-plates are available. Specify the sub-plate model number from the table above.

When sub-plates are not used, the mounting surface should have a good machined finish.

■ Mounting Bolts

For socket head cap screws in the table below are included.

Descriptions	Soc. Hd. Cap Screw (4 pcs.)	Tightening Torque
Japanese Standard "JIS" European Design Standard	M5 × 45 Lg.	5 - 7 Nm (43 - 60 in. lbs.) [Applicable to working pressure more than 25 MPa (3630 PSI): 6 - 7 Nm (52 - 60 in. lbs.)]
N. American Design Standard	No. 10-24 UNC × 1-3/4 Lg.	

Model Number Designation

F-	S-	DSG	-01	-2	B	2	A	-D24	-C	-*	-60	*	-L
Special Seals	Shockless Type	Series Number	Valve Size	Number of Valve Positions	Spool-Spring Arrangement	Spool Type	Special Two Position Valve [Omit if not required]	Coil Type	Manual Override	Electrical Conduit Connection	Design Number	Design Standard	Models with Reverse Mfg. of Solenoid [Omit if not required]
F: For Phosphate Ester Type Fluids (Omit if not required)	None: Standard Type	DSG: Solenoid Operated Directional Valve	01	3: Three Positions	C: Spring Centred	2, 3 4, 40 60, 9 10, 11 12	—	AC: A100 A120 A200 A240	None: Manual Override Pin	None: Terminal Box Type	60	None: Japanese Std. "JIS"	—
				2: Two Positions	D: No-Spring Detented	2	—	DC: D12 D24 D48	C: Push Button and Lock Nut (Option)	N: Plug-in Connector Type		None: Japanese Std. "JIS" and European Design Std.	L
S: Shockless Type				3: Three Positions	C: Spring Centred	2 40	—	DC: D12 D24 D48					
				2: Two Positions	B: Spring Offset	2 3 8	A¹ B	R: (AC → DC) R100 R200					
					B: Spring Offset	2	—	R: (AC → DC) R100 R200					L

★ 1. In case of the special two position valve, please refer to page 10 for details.
 ★ 2. NI is not available for R type solenoids.



Options

● Push Button with Lock Nut

Can be used for manual changeover of spool. The push button can be locked in the pressed condition.

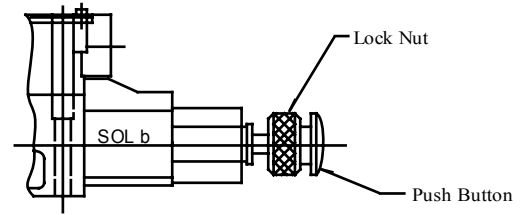

● Plug-in Connector with Solenoid Indicator Light

These are the indicator light incorporated plug-in connector type solenoids. Energisation or de-energisation of the solenoid can be easily identified with the incorporated indicator light.

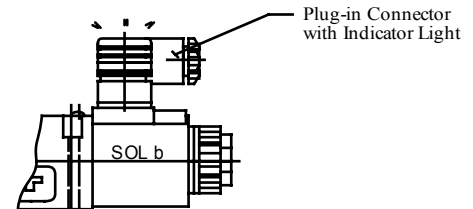

Hydraulic Fluids

● Fluid Types

Any type of hydraulic fluid, listed in the table below can be used.

Petroleum base oil	Use fluids equivalent to ISO VG32 or VG46.
Synthetic fluids	Use phosphate ester or polyol ester fluid. When phosphate ester fluid is used, prefix "F-" to the model number because the special seals (fluororubber) are required to be used.
Water containing fluids	Use water-glycol fluids or W/O emulsion fluids.

Note: For use with hydraulic fluids other than those listed above, please consult your Yuken representatives in advance.

● Recommended Viscosity and Oil Temperatures

Always be sure to use hydraulic fluids within the stipulated conditions shown below:

Viscosity: 15 to 400 mm²/s (77 to 1800 SSU), Temperature: -15 to +70°C (5 to 160°F)

● Control of Contamination

Due caution must be paid to maintaining control over contamination of the hydraulic fluids which may otherwise lead to breakdowns and shorten the life of the valve. Please maintain the degree of contamination within NAS 1638-Grade 12. Use 25 μm or finer line filter.

Instructions

● Mounting Posture

In case No-spring detented type valves are used in the solenoid de-energised state, install the valve in such a way that the axis L-L' becomes horizontal to get the detent effect firmly. For the valve types other than the above, there are no restrictions on the mounting posture.

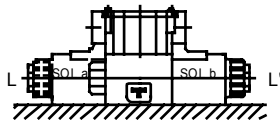

● Solenoid Energisation

For double solenoid valves do not energise both at the same time as it will result in coils burning out.

● Valve Tank Port

Avoid connecting the valve tank port to a line with possible surge pressure. Piping end of tank line should be submerged in oil.

● Shockless Type

In order to benefit from a shockless operation, it is necessary to fill the tank line with operating oil. Only after the tank line has been filled with operating oil, start the operation of the valve on a regular basis.

● Operating Force for Manual Override Push Pin



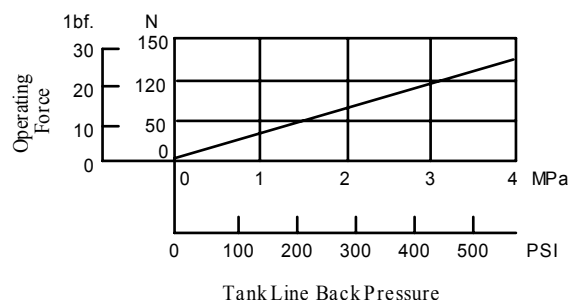







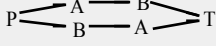
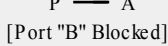

Please note that as the back pressure of the tank line rises, the manual override push pin turns hard to operate (see the graph below).

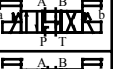

List of Standard Models

■ List of Standard Models and The Maximum Flow

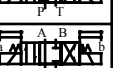
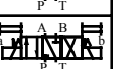
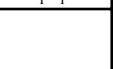
● Models with AC Solenoids: DSG-01-***-A*

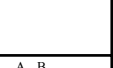
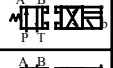
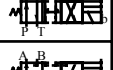
No. of Valve Positions	Spool-Spring Arrangement	Model Numbers	Graphic Symbols	Max. Flow L/min																				
									 [Port "B" Blocked]					 [Port "A" Blocked]										
																								
5 MPa					10 MPa					16 MPa					25 MPa					31.5 MPa				
Three Positions	Spring Centred	DSG-01-3C2		63	63	63	63	63	63(30)	63(23)	63(15)	50(10)	40(10)	63(30)	63(23)	63(15)	50(10)	40(10)						
		DSG-01-3C3		63	63	63	63	63	63	63	63	63	63	63	63	63	63	63						
		DSG-01-3C4		63	63	63	63	63	63(48)	63(25)	63(23)	63(20)	63(13)	55(10)	63(25)	63(23)	63(20)	63(13)	55(10)					
		DSG-01-3C40		63	63	63	63	63	63(30)	63(23)	63(15)	50(10)	40(10)	63(30)	63(23)	63(15)	50(10)	40(10)						
		DSG-01-3C60		45	43	40	40	—	45	43	40	40	—	45	43	40	40	—						
		DSG-01-3C9		63	63	63	63	63	28	20	15	10	10	28	20	15	10	10						
		DSG-01-3C10		63	63	63	63	63	63(38)	63(30)	63(25)	63(15)	63(13)	63(38)	63(30)	63(25)	63(15)	63(13)	63(38)					
		DSG-01-3C11		63	63	63	63	63	30	23	20	13	10	63	63(50)	63(50)	63(50)	63(50)						
		DSG-01-3C12		63	63	63	63	63	63(30)	63(28)	63(23)	63(18)	63(15)	63(30)	63(28)	63(23)	63(18)	63(15)	63(30)					
Two Positions	No-Spring Detented	DSG-01-2D2		63	63	63	63	63	45	45	45	45(35)	45(25)	45	45	45	45(35)	45(25)						
		DSG-01-2B2		63	63	63	63	63	20	20	20	20	20	63	63(55)	63(50)	63(50)	63(45)						
	Spring Offset	DSG-01-2B3		63	63	63	63	63	50	50	50	50	50	63	63	63	63	63						
		DSG-01-2B8		—	—	—	—	—	25	13	10	10	10	63(28)	63(25)	63(20)	63(13)	50(10)						

Notes: 1. The relation between the maximum flow in the table above and the frequency/voltage (within the serviceable voltage) is as shown below.

(Example)

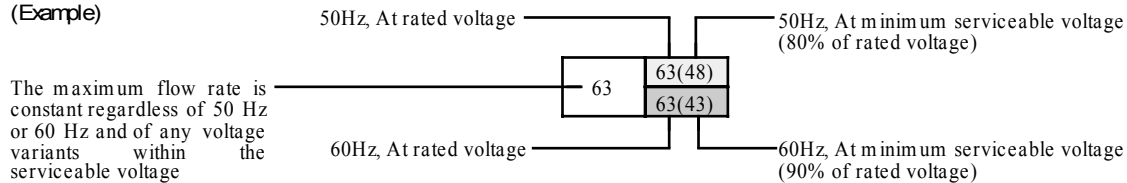

2. For the maximum flow rate in P → T of the valves with ⚡ mark, please see page 9.

The valve models with ⚡ mark are handled as Options. If you choose such valves, check the time of delivery beforehand.

List of Standard Models

List of Standard Models and The Maximum Flow

Models with AC Solenoids: DSG-01-***-A*

No. of Valve Positions	Spool-Spring Arrangement	Model Numbers	Graphic Symbols	Max. Flow U.S.GPM																				
									P — A [Port "B" Blocked]					P — B [Port "A" Blocked]										
730 PSI					1450 PSI					2320 PSI					3630 PSI					4570 PSI				
Three Positions	Spring Centred	DSG-01-3C2		16.6	16.6	16.6	16.6	16.6	16.6 (7.9)	16.6 (6.1)	16.6 (4.0)	13.2 (2.6)	10.6 (2.6)	16.6 (7.9)	16.6 (6.1)	16.6 (4.0)	13.2 (2.6)	10.6 (2.6)	16.6 (7.9)	16.6 (6.1)	16.6 (4.0)	13.2 (2.6)	10.6 (2.6)	
		DSG-01-3C3		16.6	16.6	16.6	16.6	16.6	16.6	16.6	16.6	16.6	16.6	16.6	16.6	16.6	16.6	16.6	16.6	16.6	16.6	16.6	16.6	
		DSG-01-3C4		16.6	16.6	16.6	16.6	16.6 (12.7)	16.6 (6.6)	16.6 (6.1)	16.6 (5.3)	16.6 (3.4)	14.5 (2.6)	16.6 (6.6)	16.6 (6.1)	16.6 (5.3)	16.6 (3.4)	14.5 (2.6)	16.6 (6.6)	16.6 (6.1)	16.6 (5.3)	16.6 (3.4)	14.5 (2.6)	
		DSG-01-3C40		16.6	16.6	16.6	16.6	16.6	16.6 (7.9)	16.6 (6.1)	16.6 (4.0)	13.2 (2.6)	10.6 (2.6)	16.6 (7.9)	16.6 (6.1)	16.6 (4.0)	13.2 (2.6)	10.6 (2.6)	16.6 (7.9)	16.6 (6.1)	16.6 (4.0)	13.2 (2.6)	10.6 (2.6)	
		DSG-01-3C60		11.9	11.4	10.6	10.6	—	11.9	11.4	10.6	10.6	—	11.9	11.4	10.6	10.6	—	11.9	11.4	10.6	10.6	—	
		DSG-01-3C9		16.6	16.6	16.6	16.6	16.6	7.4	5.3	4.0	2.6	2.6	7.4	5.3	4.0	2.6	2.6	7.4	5.3	4.0	2.6	2.6	
		DSG-01-3C10		16.6	16.6	16.6	16.6	16.6	16.6 (10.6)	16.6 (7.9)	16.6 (6.6)	16.6 (4.0)	16.6 (3.4)	16.6 (10.6)	16.6 (7.9)	16.6 (6.6)	16.6 (4.0)	16.6 (3.4)	16.6 (10.6)	16.6 (7.9)	16.6 (6.6)	16.6 (4.0)	16.6 (3.4)	
		DSG-01-3C11		16.6	16.6	16.6	16.6	16.6	7.9	6.1	5.3	3.4	2.6	16.6 (15.2)	16.6 (13.2)	16.6 (11.2)	16.6 (11.2)	16.6 (11.2)	16.6 (15.2)	16.6 (13.2)	16.6 (11.2)	16.6 (11.2)	16.6 (11.2)	
		DSG-01-3C12		16.6	16.6	16.6	16.6	16.6	16.6 (7.9)	16.6 (7.4)	16.6 (6.1)	16.6 (4.8)	16.6 (4.0)	16.6 (7.9)	16.6 (7.4)	16.6 (6.1)	16.6 (4.8)	16.6 (4.0)	16.6 (7.9)	16.6 (7.4)	16.6 (6.1)	16.6 (4.8)	16.6 (4.0)	
		Two Positions	No-Spring Detented	DSG-01-2D2		16.6	16.6	16.6	16.6	16.6	11.9	11.9	11.9	11.9 (9.2)	11.9 (6.6)	11.9	11.9	11.9	11.9 (9.2)	11.9 (6.6)	11.9	11.9	11.9	
DSG-01-2B2				16.6	16.6	16.6	16.6	16.6	5.3	5.3	5.3	5.3	5.3	16.6	16.6 (14.5)	16.6 (13.2)	16.6 (11.2)	16.6 (11.2)	16.6	16.6 (14.5)	16.6 (13.2)	16.6 (11.2)	16.6 (11.2)	
DSG-01-2B3				16.6	16.6 (15.2)	16.6 (15.2)	16.6 (15.2)	16.6 (15.2)	13.2	13.2	13.2	13.2	13.2	16.6 (14.5)	16.6 (14.5)	16.6 (14.5)	16.6 (14.5)	16.6 (14.5)	16.6 (14.5)	16.6 (14.5)	16.6 (14.5)	16.6 (14.5)	16.6 (14.5)	
Spring Offset	DSG-01-2B8			—	—	—	—	—	6.6	3.4	2.6	2.6	2.6	16.6 (7.4)	16.6 (6.6)	16.6 (5.3)	16.6 (3.4)	13.2 (2.6)	16.6 (7.4)	16.6 (6.6)	16.6 (5.3)	16.6 (3.4)	13.2 (2.6)	
	DSG-01-2B2			16.6	16.6	16.6	16.6	16.6	5.3	5.3	5.3	5.3	5.3	16.6	16.6 (14.5)	16.6 (13.2)	16.6 (11.2)	16.6 (11.2)	16.6	16.6 (14.5)	16.6 (13.2)	16.6 (11.2)	16.6 (11.2)	
	DSG-01-2B3			16.6	16.6 (15.2)	16.6 (15.2)	16.6 (15.2)	16.6 (15.2)	13.2	13.2	13.2	13.2	13.2	16.6 (14.5)	16.6 (14.5)	16.6 (14.5)	16.6 (14.5)	16.6 (14.5)	16.6 (14.5)	16.6 (14.5)	16.6 (14.5)	16.6 (14.5)	16.6 (14.5)	

Notes: 1. The relation between the maximum flow in the table above and the frequency/voltage (within the serviceable voltage) is as shown below.

(Example)

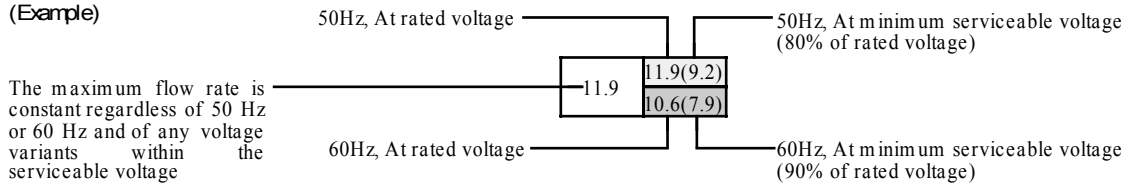







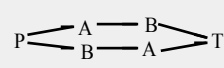
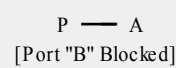
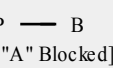
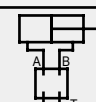
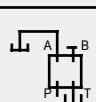
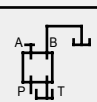

2. For the maximum flow rate in P → T of the valves with ★ mark, please see page 9.

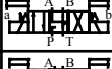
The valve models with ▲ mark are handled as Options. If you choose such valves, check the time of delivery beforehand.

■ List of Standard Models and The Maximum Flow

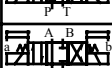
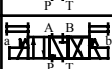
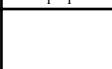
● Models with DC or R Type Solenoids: DSG-01-***-D*/R*

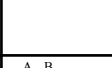
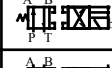
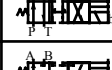
No. of Valve Positions	Spool+Spring Arrangement	Model Numbers	Graphic Symbols	Max. Flow L/min															
									 [Port "B" Blocked]					 [Port "A" Blocked]					
																			
		5 MPa	10 MPa	16 MPa	25 MPa	31.5 MPa	5 MPa	10 MPa	16 MPa	25 MPa	31.5 MPa	5 MPa	10 MPa	16 MPa	25 MPa	31.5 MPa			
Three Positions	Spring Centred	DSG-01-3C2		63	63	63	63	63	45	30	20	15	13	45	30	20	15	13	
		DSG-01-3C3		63	63	63	63	63	63	63	63	63	63	63	63	63	63	63	63
		DSG-01-3C4		63	63	63	63	35	63	45	35	30	28	63	45	35	30	28	
		DSG-01-3C40		63	63	63	63	63	45	30	20	15	13	45	30	20	15	13	
		DSG-01-3C60		45	43	40	40	—	45	43	40	40	—	45	43	40	40	—	
		DSG-01-3C9		63	63	63	63	63	25	20	15	10	10	25	20	15	10	10	
		DSG-01-3C10		63	63	63	63	45	63	55	40	28	20	63	55	40	28	20	
		DSG-01-3C11		63	63	63	63	63	30	23	20	13	10	63	58	55	55	55	
		DSG-01-3C12		63	63	63	63	38	63	60	40	25	20	63	60	40	25	20	
Two Positions	No-Spring Detented	DSG-01-2D2		63	63	63	63	63	45	45	45	40	30	45	45	45	40	30	
		58	55	55	55	55	30	25	30	25									
	Spring Offset	DSG-01-2B2		63	63	63	63	63	20	18	18	18	18	63	58	40	30	30	
		53	53	53	53	53	40	28	25	25									
		DSG-01-2B3		38	38	38	38	38	48	48	45	45	40	63	63	63	63	63	
		28	28	28	28	28	45	45	40	40	38	60	60	60	60				
		DSG-01-2B8		—	—	—	—	—	25	13	10	8	8	63	48	28	15	15	
30	20	13	10																

Notes: 1. The relation between the maximum flow in the table above and the voltage (within the serviceable voltage) is as shown below.

(Example)

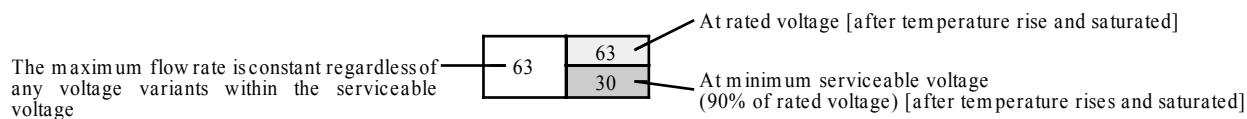











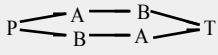
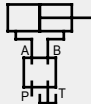

2. For the maximum flow rate in P → T of the valves with ★ mark, please see page 9.

The valve models with ★ mark are handled as Options. If you choose such valves, check the time of delivery beforehand.

List of Standard Models

■ List of Standard Models and The Maximum Flow

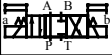
● Models with DC or R Type Solenoids: DSG-01-***-D*/R*

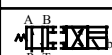
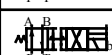
No. of Valve Positions	Spool-Spring Arrangement	Model Numbers	Graphic Symbols	Max. Flow U.S.GPM														
									P — A [Port "B" Blocked]					P — B [Port "A" Blocked]				
																		
730 PSI	1450 PSI	2320 PSI	3630 PSI	4570 PSI	730 PSI	1450 PSI	2320 PSI	3630 PSI	4570 PSI	730 PSI	1450 PSI	2320 PSI	3630 PSI	4570 PSI				
Three Positions	Spring Centred	DSG-01-3C2		16.6	16.6	16.6	16.6	16.6	11.9	7.9	5.3	4.0	3.4	11.9	7.9	5.3	4.0	3.4
		DSG-01-3C3		16.6	16.6	16.6	16.6	16.6	16.6	16.6	16.6	16.6	16.6	16.6	16.6	16.6	16.6	16.6
		DSG-01-3C4		16.6	16.6	16.6	16.6	9.2	16.6	11.9	9.2	7.9	7.4	16.6	11.9	9.2	7.9	7.4
		DSG-01-3C40		16.6	16.6	16.6	16.6	16.6	11.9	7.9	5.3	4.0	3.4	11.9	7.9	5.3	4.0	3.4
		DSG-01-3C60		11.9	11.4	10.6	10.6	—	11.9	11.4	10.6	10.6	—	11.9	11.4	10.6	10.6	—
		DSG-01-3C9		16.6	16.6	16.6	16.6	16.6	6.6	5.3	4.0	2.6	2.6	6.6	5.3	4.0	2.6	2.6
		DSG-01-3C10		16.6	16.6	16.6	16.6	11.9	16.6	14.5	10.6	7.4	5.3	16.6	14.5	10.6	7.4	5.3
		DSG-01-3C11		16.6	16.6	16.6	16.6	16.6	7.9	6.1	5.3	3.4	2.6	16.6	15.3	14.5	14.5	14.5
		DSG-01-3C12		16.6	16.6	16.6	16.6	10	16.6	15.9	10.6	6.6	5.3	16.6	15.9	10.6	6.6	5.3
Two Positions	No-Spring Detented	DSG-01-2D2		16.6	16.6	16.6	16.6	16.6	11.9	11.9	11.9	10.6	7.9	11.9	11.9	11.9	10.6	7.9
				15.3	14.5	14.5	14.5	14.5				7.9	6.6				7.9	6.6
	Spring Offset	DSG-01-2B2		16.6	16.6	16.6	16.6	16.6	5.3	4.8	4.8	4.8	4.8	16.6	15.3	10.6	7.9	7.9
				14	14	14	14	14							10.6	7.4	6.6	6.6
				10	10	10	10	10							16.6	16.6	16.6	16.6
				7.4	7.4	7.4	7.4	7.4							15.9	15.9	15.9	15.9
				—	—	—	—	—							12.7	7.4	4.0	4.0
DSG-01-2B8		—	—	—	—	—	6.6	3.4	2.6	2.1	2.1	16.6	7.9	5.3	3.4	2.6		

Notes: 1. The relation between the maximum flow in the table above and the voltage (within the serviceable voltage) is as shown below.

(Example)

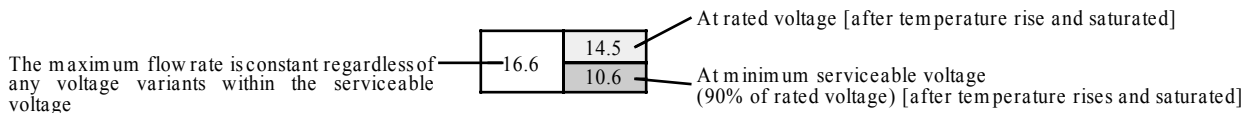

2. For the maximum flow rate in P → T of the valves with ★ mark, please see page 9.

The valve models with ▲ mark are handled as Options. If you choose such valves, check the time of delivery beforehand.

Maximum Flow of Centre By-Pass

In valve type 3C60, in case where the actuator is put on in between the cylinder ports A and B as illustrated below and where the actuator moves and suspended at its stroke end and where the valve is then shifted to the neutral position in the suspended state of the actuator, the maximum flow rates available are those as shown as the table below regardless of any voltage in the range of serviceable voltage.

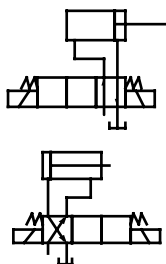

Mode Numbers	Graphic Symbol	Max. Flow L/m in (U.S.GPM)			
		5 MPa (730 PSI)	10 MPa (1450 PSI)	16 MPa (2320 PSI)	25 MPa (3630 PSI)
DSG-01-3C60-A*/D*/R*		45 (11.9)	43 (11.4)	40 (10.6)	30 (7.9)

List of Shockless Models and The Maximum Flow

Models with DC or R Type Solenoids: S-DSG-01-***-D*/R*

No. of Valve Positions	Spool-Spring Arrangement	Model Numbers	Graphic Symbols	Max. Flow L/m in (U.S.GPM)								
							 [Port "B" Blocked]			 [Port "A" Blocked]		
				5 MPa (730 PSI)	10 MPa (1450)	16 MPa (2320)	5 MPa (730 PSI)	10 MPa (1450)	16 MPa (2320)	5 MPa (730 PSI)	10 MPa (1450)	16 MPa (2320)
Three Positions	Spring Centred	S-DSG-01-3C2		40 (10.6)	40 (10.6)	40 (10.6)	40 (10.6)	40 (10.6) 20 (5.3)	30 (7.9) 15 (4.0)	40 (10.6)	40 (10.6) 20 (5.3)	30 (7.9) 15 (4.0)
		S-DSG-01-3C4		40 (10.6)	40 (10.6)	40 (10.6)	40 (10.6)	40 (10.6) 20 (5.3)	30 (7.9) 15 (4.0)	40 (10.6)	40 (10.6) 20 (5.3)	30 (7.9) 15 (4.0)
Two Positions	Spring Offset	S-DSG-01-2B2		40 (10.6)	40 (10.6)	40 (10.6)	30 (7.9)	30 (7.9)	30 (7.9)	40 (10.6)	40 (10.6)	30 (7.9)
					35 (9.2)	35 (9.2)					20 (5.3)	15 (4.0)

Note: The relation between the maximum flow in the table above and the voltage (within the serviceable voltage) is as shown below.

(Example)

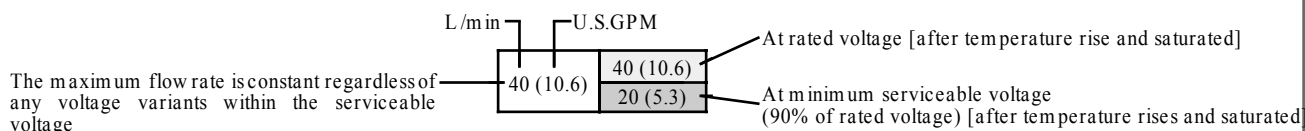

Reverse Mounting of Solenoid.

In spring offset type, it is a standard configuration that the solenoid is mounted onto the valve in the SOL b position (side). However, in this particular spool-spring arrangement, the mounting of the solenoid onto the valve in the reverse position -SOL a side- is also available. The graphic symbol for this reverse mounting is as shown below. As for the valve type 2B* A and 2B* B, please refer to the explanation under the heading of "Valves Using Neutral Position and Side Position" given below.

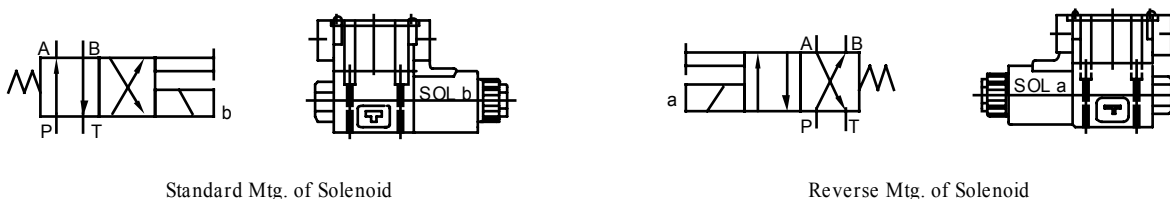

Valves Using Neutral Position and Side Position. (Special Two position Valve)

Besides the use of the standard 2-position valves aforementioned in the "List of Standard Models and Maximum Flow", the 3-position valves also can be used as the 2-position valves using the two of their three positions. In this case, there are two kinds of the valve available. One is the valve using the neutral position and SOL a position (2B* A) and another is the valve using the neutral position and SOL b position (2B* B).

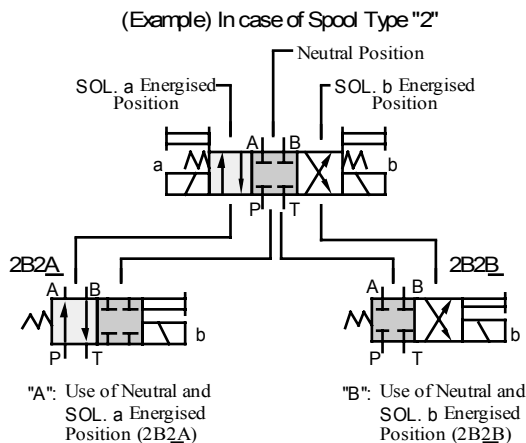

Model Numbers	Graphic Symbols	
	Standard Mtg. Type	Reverse Mtg. Type
DSG-01-2B* <u>A</u>		
DSG-01-2B2A		—

Model Numbers	Graphic Symbols	
	Standard Mtg. Type	Reverse Mtg. Type
DSG-01-2B* <u>B</u>		
DSG-01-2B2B		—
DSG-01-2B3B		—
DSG-01-2B4B		
DSG-01-2B60B		—
DSG-01-2B10B		—

In the above table, the graphic symbols in mounting type highlighted with shade are optional extra, therefore, please confirm the time of delivery with us before ordering.

■ Typical Changeover Time

Changeover time varies according to oil viscosity, spool type and hydraulic circuit.

● Standard Type (Without Shockless Function)

[Test Conditions]

Pressure: 16 MPa (2320 PSI)
Flow Rate: 31.5 L/min (8.3 U.S.GPM)
Viscosity: 35 mm²/s (164 SSU)
Voltage: 100 %V
(After coil temperature rises and saturated)

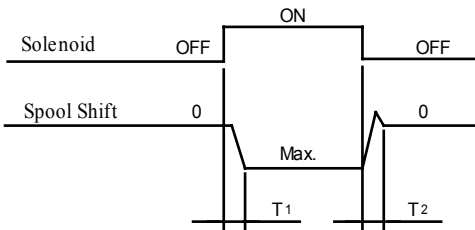

[Result of Measurement]

Type	Model Numbers	Time ms	
		T ₁	T ₂
Standard Type	DSG-01-3C2-A*	15	23
	DSG-01-3C2-D*	48	19
	DSG-01-3C2-R*	50	100

● Shockless Type

[Test Circuit and Conditions]

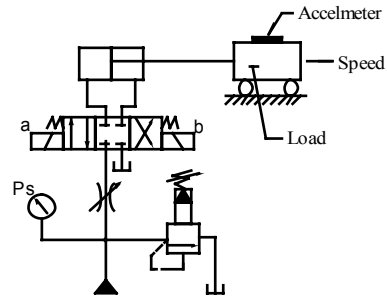

Setting Pressure (Ps): 7 MPa (1020 PSI)
Load (W): 1000 kg (2205 lbs.)
Speed: 8 m/min (27 ft./min)
Viscosity: 35 mm²/s (164 SSU)

[Results of Measurement]

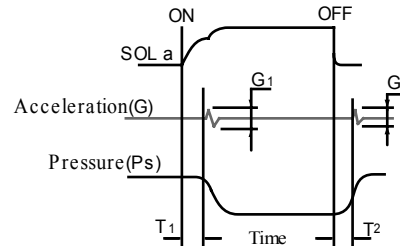

Type	Model Numbers	Time ms		Acceleration m/s ² (G)	
		T ₁	T ₂	G ₁	G ₂
Shockless Type	S-DSG-01-3C2-D*	70	30	12 (1.2)	7 (0.7)
Standard Type	DSG-01-3C2-D*	35	25	18 (1.8)	15 (1.5)

Pressure Drop

■ Pressure Drop

Pressure drop curves based on viscosity of 35 mm²/s (164 SSU) and specific gravity of 0.850.

● Standard Type: DSG-01

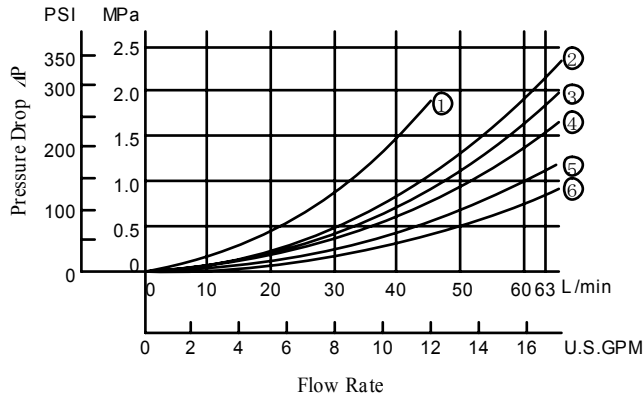

Model Numbers	Pressure Drop Curve Number				
	P→A	B→T	P→B	A→T	P→T
DSG-01-3C2	⑤	⑤	⑤	⑤	—
DSG-01-3C3	⑥	⑥	⑥	⑥	④
DSG-01-3C4	⑤	⑥	⑤	⑥	—
DSG-01-3C40	⑤	⑤	⑤	⑤	—
DSG-01-3C60	①	①	①	①	④
DSG-01-3C9	⑥	⑤	⑥	⑤	—
DSG-01-3C10	⑤	⑥	⑤	⑤	—
DSG-01-3C11	⑥	⑤	⑤	⑤	—
DSG-01-3C12	⑤	⑤	⑤	⑥	—
DSG-01-2D2	⑤	②	⑤	②	—
DSG-01-2B2	②	②	⑤	⑤	—
DSG-01-2B3	③	③	⑤	⑥	—
DSG-01-2B8	⑤	—	⑤	—	—

● Shockless Type: S-DSG-01

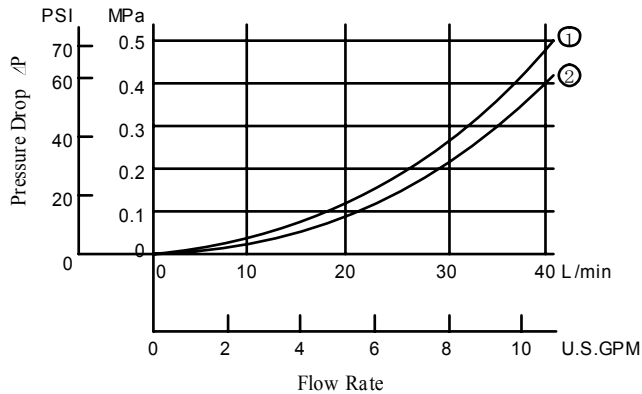

Model Numbers	Pressure Drop Curve No.			
	P→A	B→T	P→B	A→T
S-DSG-01-3C2	①	①	①	①
S-DSG-01-3C4	①	②	①	②
S-DSG-01-2B2	①	①	①	①

● For any other viscosity, multiply the factors in the table below.

Viscosity	m ² /s	15	20	30	40	50	60	70	80	90	100
	SSU		77	98	141	186	232	278	324	371	417
Factor		0.81	0.87	0.96	1.03	1.09	1.14	1.19	1.23	1.27	1.30

● For any other specific gravity (G'), the pressure drop (P') may be obtained from the formula below.

$$P' = AP (G'/0.850)$$

TERMINAL BOX TYPE

Models with AC Solenoids

Double Solenoid: Spring Centred & No-Spring Detented

DSG-01-^{3C*}
2D2-A*-60/6090

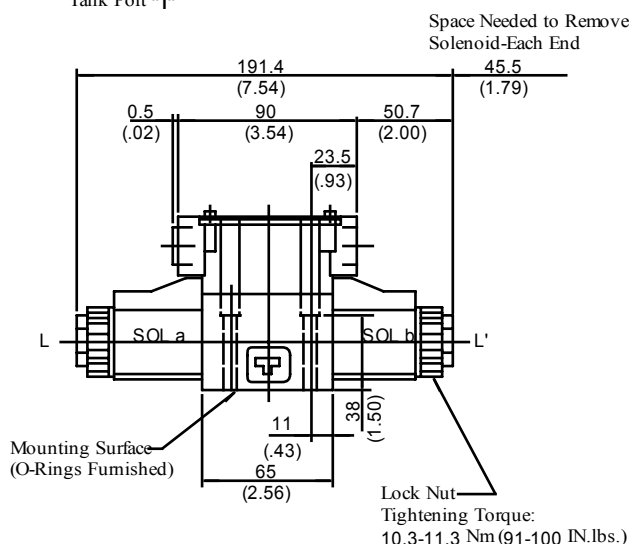
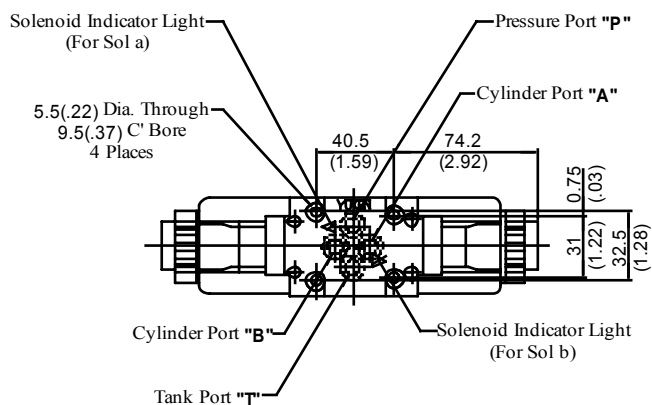

Model Numbers	"C" Thd.
DSG-01-***-A*-60	G 1/2
DSG-01-***-A*-	1/2 NPT

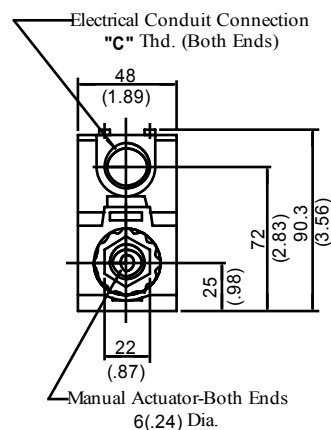

DIMENSIONS IN MILLIMETRES (INCHES)

Single Solenoid: Spring Offset

DSG-01-2B*-A*-60/6090

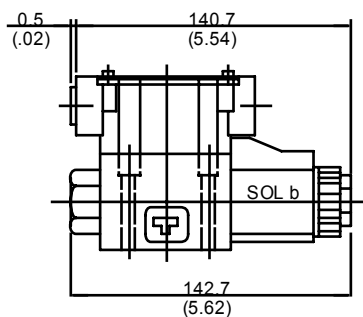

- For other dimensions, refer to "Spring Centred and No-Spring Detented" models.
- Solenoid being mounted in the reverse position -SOL a side- is also available.

TERMINAL BOX TYPE

Mounting surface: ISO 4401-AB-03-4-A

- Models with DC Solenoids : (S-)DSG-01-***-D*-60/6090
- Models with R Type Solenoids : (S-)DSG-01-***-R*-60/6090
- Spring Centred
- No-Spring Detented
- Spring Offset

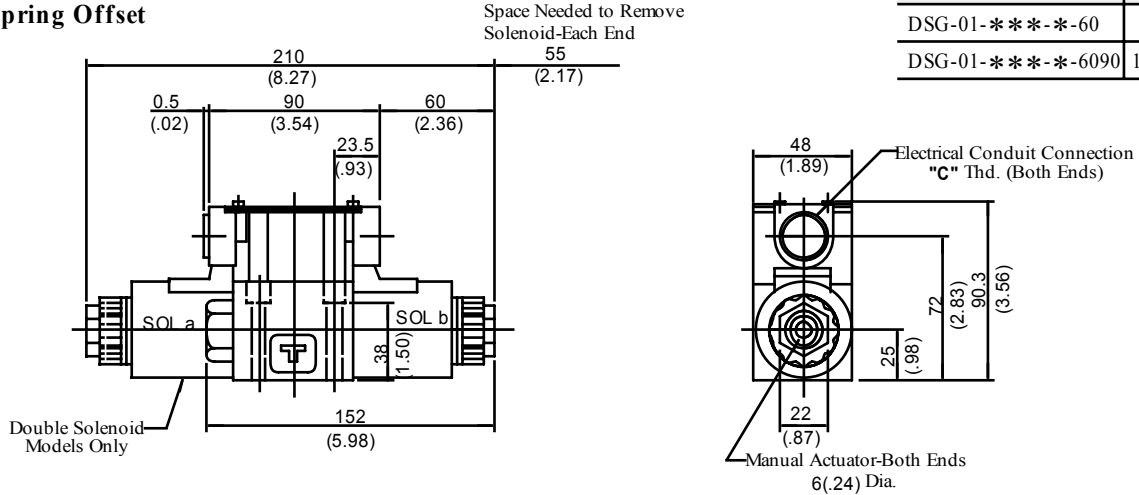

● For other dimensions, refer to models with AC solenoids (Page 13).

DIMENSIONS IN
MILLIMETRES (INCHES)

- Sub-plate : DSGM-01/01X/01Y-30/3080/3090

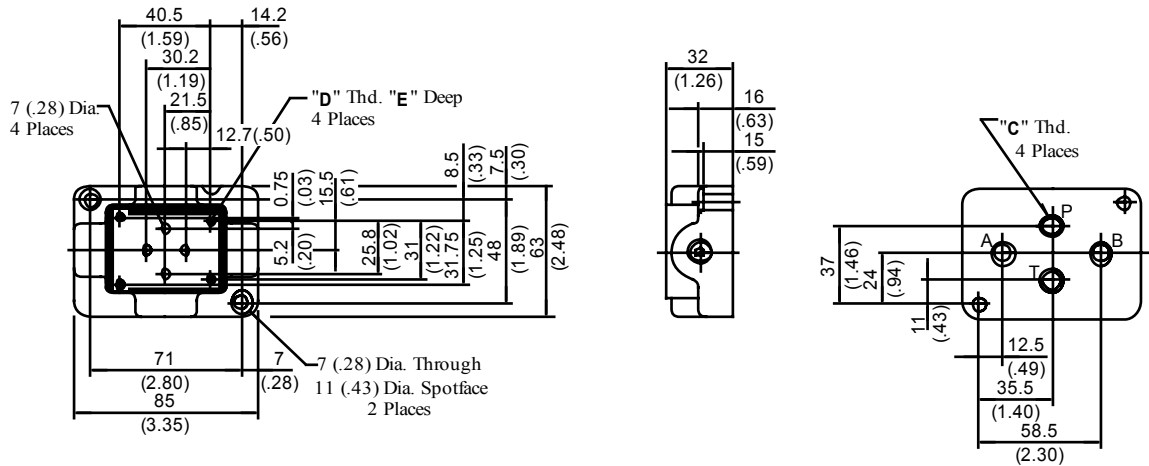

Sub-plate Model Numbers	Piping Size "C" Thd.	"D" Thd.	"E" mm (IN.)
DSGM-01-30	Rc 1/8	M5	10 (.39)
DSGM-01-3080	1/8 BSP.F		
DSGM-01-3090	1/8 NPT	No.10-24 UNC	12 (.47)
DSGM-01X-30	Rc 1/4	M5	10 (.39)
DSGM-01X-3080	1/4 BSP.F		
DSGM-01X-3090	1/4 NPT	No.10-24 UNC	12 (.47)
DSGM-01Y-30	Rc 3/8	M5	10 (.39)
DSGM-01Y-3090	3/8 NPT	No. 10-24 UNC	12 (.47)

■ PLUG-IN CONNECTOR TYPE (N)
PLUG-IN CONNECTOR WITH INDICATOR LIGHT (N1)

DIMENSIONS IN
MILLIMETRES (INCHES)

- Models with AC Solenoids: DSG-01-***-A*^N_{N1}-60/6090

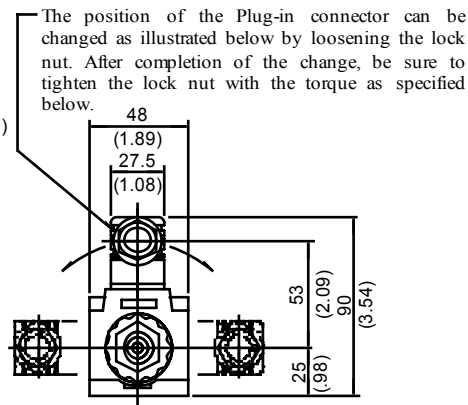
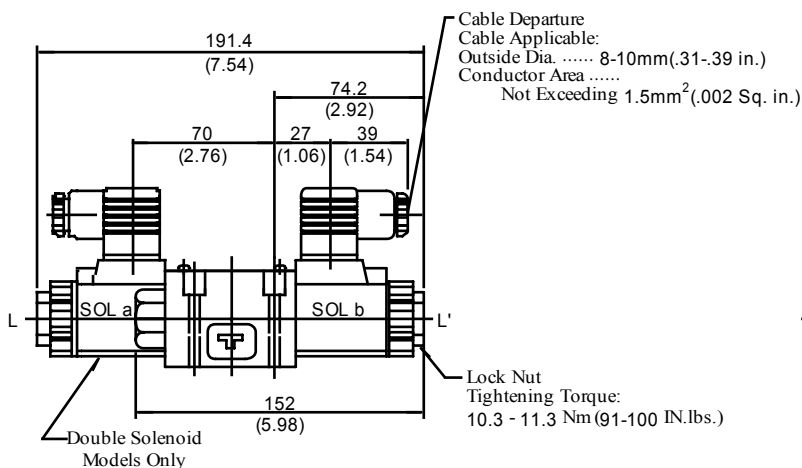

- Models with DC Solenoids: (S-)DSG-01-***-D*^N_{N1}-60/6090
- Models with R Solenoids: (S-)DSG-01-***-R*^N_{N1}-60/6090

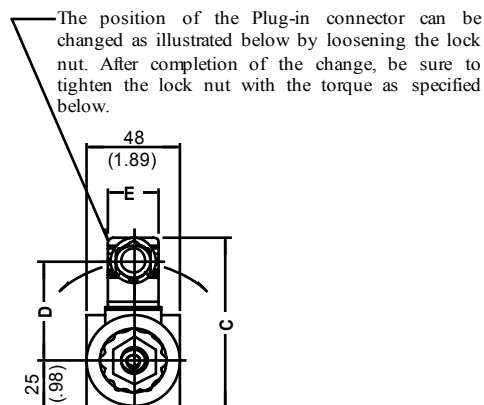
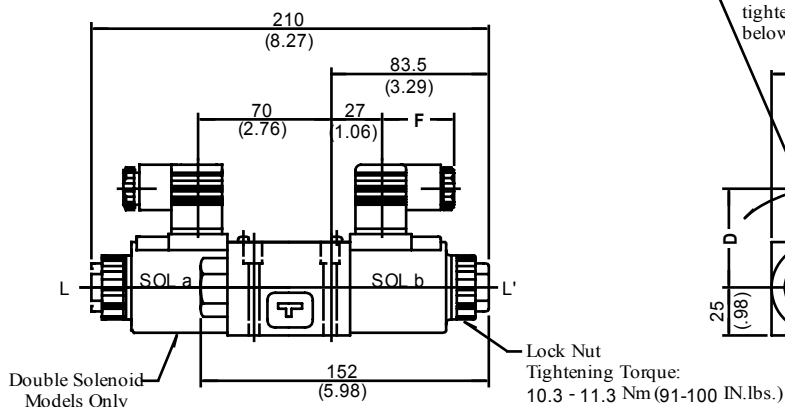

Model Numbers	Dimensions mm (Inches)			
	C	D	E	F
(S-)DSG-01-***-D*-N/N1-60/	101 (3.98)	64 (2.52)	27.5 (1.08)	39 (1.54)
6090	104 (4.09)	57.2 (2.25)	34 (1.34)	53 (2.09)

● For other dimensions, refer to "Terminal Box type" (Page 13 to 14).

■ Models with Push Button & Lock Nut
(S-)DSG-01-***-C

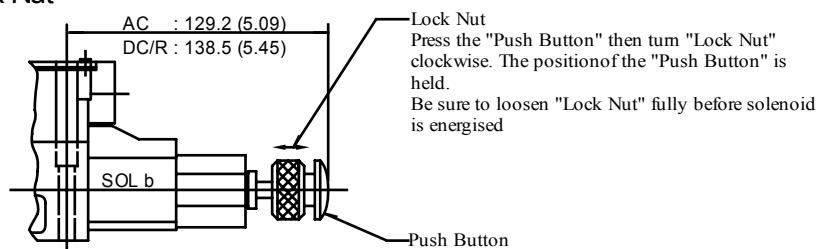

Details of Receptacle

Type of Electrical Conduit Connection	Double Solenoid Type	Single Solenoid Type
Terminal Box Type		
Plug-in Connector Type		

- ★ 1. There are two grounding terminals. You can use either one.
- ★ 2. If you do not need the common plate, remove it.
- ★ 3. With DC solenoids, polarity is no question.

⚠ DANGER

- Do not perform wiring while the power is on. Doing so may result in electric shock, burns or death.
- Make the wiring properly. Improper wiring will cause an irregular movement of the machine, resulting in a grave accident.

Electrical Circuit

Type of Electrical Conduit Connection	Electric Source		
	AC	DC	AC → DC Rectified
Terminal Box Type			
Plug-in Connector Type			

*-DSG-01-***-*-60/6090

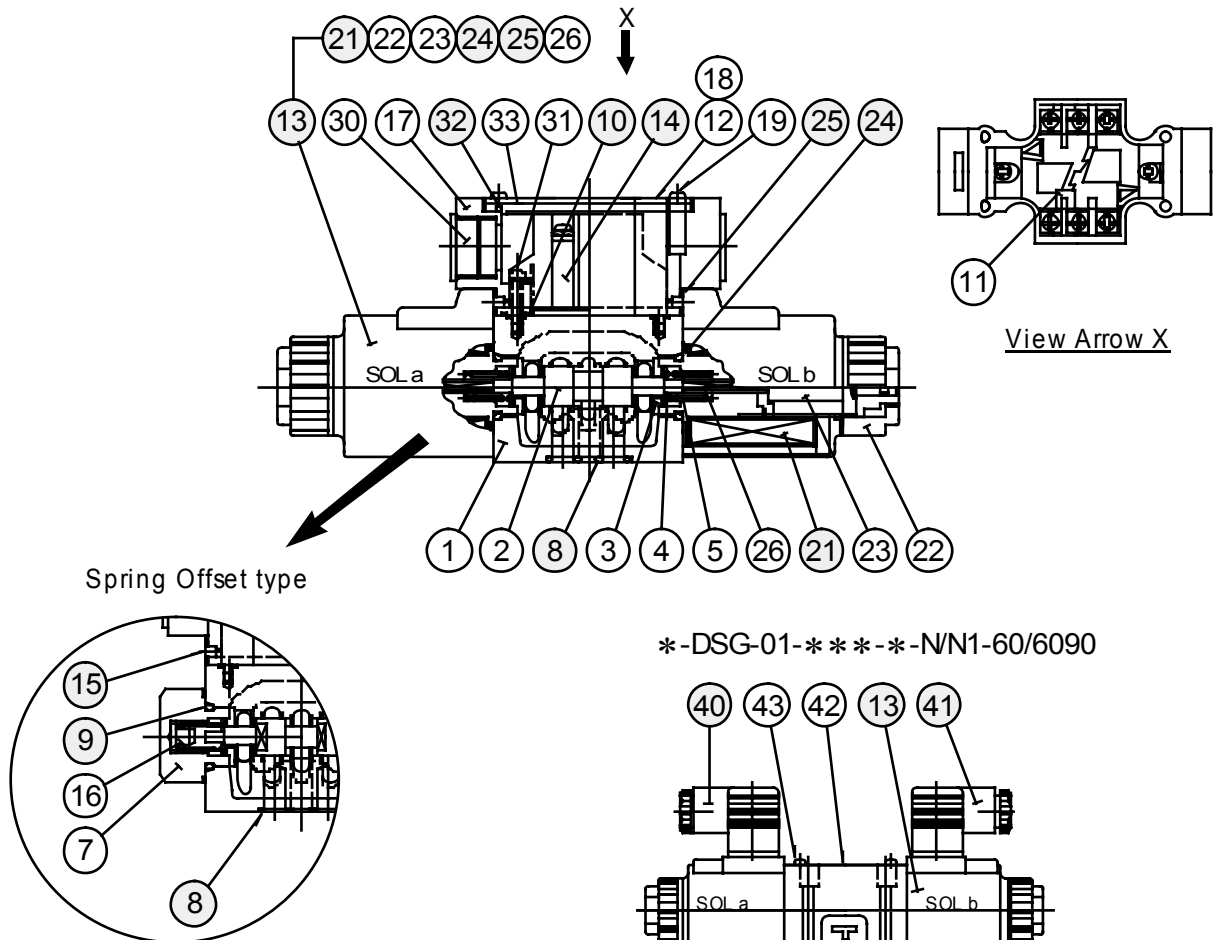

*-DSG-01-***-*-N/N1-60/6090

● List of Seals

Item	Name of Parts	Part Numbers	Qty.			Remarks
			3C*	2D2	2B*	
8	O-Ring	SO-NB-P9	4	4	4	
9	O-Ring	SO-NB-P18	—	—	1	
10	O-Ring	S6	2	2	2	
15	O-Ring	1790S-VK418329-9	—	—	2	
24	O-Ring	SO-NB-P18	2	2	1	} Included in Solenoid Ass'y (Item 13)
25	O-Ring	SO-NA-P4	4	4	2	
32	Packing	1790S-VK418328-1	1	1	1	

★ When ordering the O-Rings, please specify the seal kit number from the table below.

Valve Model Numbers	Seal Kit No.	O-Ring Details for Seal Kit
*-DSG-01-***-*-60/6090	KS-DSG-01-60	(8) (4 Pcs.), (9) & (24) (2 Pcs., see above) (25) (4 Pcs.)
*-DSG-01-***-*-N-60/6090	KS-DSG-01-N-60	(8) (4 Pcs.), (9) & (24) (2 Pcs., see above)

● Solenoid Ass'y, Coil, Receptacle and Connector

Refer to Page 18 for the details of these parts.

⚠ CAUTION

When making replacement of seals, please do it carefully after reading through the relevant instructions in the Operator's Manual.

⚠ WARNING

Before maintenance or removal, do the following, Failure to do these may cause components to move, causing oil leakage or the equipment's power supply, and be sure that serious accidents.

- Return pressure in all hydraulic systems to zero.

Spare Parts List

● Solenoid Ass'y, Coil, Receptacle and Connector Ass'y No.

Valve Model Numbers	⑬ Solenoid Ass'y No.	⑳ Coil No.	⑭ Receptacle Part No.	④① Connector Ass'y Part No.	④② Connector Ass'y Part No.	Remarks
DSG-01-***-A100-60*	SA1-100-60	C-SA1-100-60	R1-60	—	—	Terminal Box Type
DSG-01-***-A120-60*	SA1-120-60	C-SA1-120-60				
DSG-01-***-A200-60*	SA1-200-60	C-SA1-200-60				
DSG-01-***-A240-60*	SA1-240-60	C-SA1-240-60				
DSG-01-***-D12-60*	SD1-12-60	C-SD1-12-60	KR1-A-60			
DSG-01-***-D24-60*	SD1-24-60	C-SD1-24-60	KR1-B-60			
DSG-01-***-D48-60*	SD1-48-60	C-SD1-48-60	RR1-60			
DSG-01-***-R100-60*	SR1-100-60	C-SR1-100-60	KR1-A-60			
DSG-01-***-R200-60*	SR1-200-60	C-SR1-200-60	KR1-B-60			
S-DSG-01-***-D12-60*	SD1-12-S-60	C-SD1-12-60	RR1-60			
S-DSG-01-***-D24-60*	SD1-24-S-60	C-SD1-24-60				
S-DSG-01-***-D48-60*	SD1-48-S-60	C-SD1-48-60				
S-DSG-01-***-R100-60*	SR1-100-S-60	C-SR1-100-60				
S-DSG-01-***-R200-60*	SR1-200-S-60	C-SR1-200-60				
DSG-01-***-A100-N-60*	SA1-100-N-60	C-SA1-100-N-60	—	GDM-211-A-11	GDM-211-B-11	Plug-in Connector Type
DSG-01-***-A120-N-60*	SA1-120-N-60	C-SA1-120-N-60				
DSG-01-***-A200-N-60*	SA1-200-N-60	C-SA1-200-N-60				
DSG-01-***-A240-N-60*	SA1-240-N-60	C-SA1-240-N-60				
DSG-01-***-D12-N-60*	SD1-12-N-60	C-SD1-12-N-60				
DSG-01-***-D24-N-60*	SD1-24-N-60	C-SD1-24-N-60				
DSG-01-***-D48-N-60*	SD1-48-N-60	C-SD1-48-N-60				
DSG-01-***-R100-N-60*	SR1-100-N-60	C-SR1-100-N-60				
DSG-01-***-R200-N-60*	SR1-200-N-60	C-SR1-200-N-60				
S-DSG-01-***-D12-N-60*	SD1-12-S-N-60	C-SD1-12-N-60				
S-DSG-01-***-D24-N-60*	SD1-24-S-N-60	C-SD1-24-N-60				
S-DSG-01-***-D48-N-60*	SD1-48-S-N-60	C-SD1-48-N-60				
S-DSG-01-***-R100-N-60*	SR1-100-S-N-60	C-SR1-100-N-60				
S-DSG-01-***-R200-N-60*	SR1-200-S-N-60	C-SR1-200-N-60				
DSG-01-***-A100-N1-60*	SA1-100-N-60	C-SA1-100-N-60	—	GDM-211-R-A-10	GDM-211-R-B-10	Plug-in Connector with Indicator Light
DSG-01-***-A120-N1-60*	SA1-120-N-60	C-SA1-120-N-60				
DSG-01-***-A200-N1-60*	SA1-200-N-60	C-SA1-200-N-60				
DSG-01-***-A240-N1-60*	SA1-240-N-60	C-SA1-240-N-60				
DSG-01-***-D12-N1-60*	SD1-12-N-60	C-SD1-12-N-60				
DSG-01-***-D24-N1-60*	SD1-24-N-60	C-SD1-24-N-60				
DSG-01-***-D48-N1-60*	SD1-48-N-60	C-SD1-48-N-60				
S-DSG-01-***-D12-N1-60	SD1-12-S-N-60	C-SD1-12-N-60				
S-DSG-01-***-D24-N1-60	SD1-24-S-N-60	C-SD1-24-N-60				
S-DSG-01-***-D48-N1-60	SD1-48-S-N-60	C-SD1-48-N-60				
DSG-01-***-A100-N1-60*	SA1-100-N-60	C-SA1-100-N-60	GDM-211-1-11	GDM-211-1-11		
DSG-01-***-A120-N1-60*	SA1-120-N-60	C-SA1-120-N-60	GDML-211-2-11	GDML-211-2-11		
DSG-01-***-A200-N1-60*	SA1-200-N-60	C-SA1-200-N-60	GDML-211-3-11	GDML-211-3-11		
DSG-01-***-D12-N1-60*	SD1-12-N-60	C-SD1-12-N-60	GDML-211-1-11	GDML-211-1-11		
DSG-01-***-D24-N1-60*	SD1-24-N-60	C-SD1-24-N-60	GDML-211-2-11	GDML-211-2-11		
DSG-01-***-D48-N1-60*	SD1-48-N-60	C-SD1-48-N-60	GDML-211-3-11	GDML-211-3-11		
S-DSG-01-***-D12-N1-60	SD1-12-S-N-60	C-SD1-12-N-60	GDML-211-1-11	GDML-211-1-11		
S-DSG-01-***-D24-N1-60	SD1-24-S-N-60	C-SD1-24-N-60	GDML-211-2-11	GDML-211-2-11		
S-DSG-01-***-D48-N1-60	SD1-48-S-N-60	C-SD1-48-N-60	GDML-211-3-11	GDML-211-3-11		

Note: The connector assembly is not included in the solenoid assembly.

To improve product qualities and facilitate the supply of product, the solenoid operated directional valves, DSG-01 series have been model-changed from 50 to 60 design. The new and current models can be compared as follows:

- Specifications and Characteristics

There are no changes in the specifications and characteristics of the valves themselves.

- Solenoid Ratings

There are changes in the inrush current, holding current and power as shown below. No other changes.

Valve Type	Electric Source	Coil Type	Frequency (Hz)	Voltage (V)		Current & Power at Rated Voltage					
				Source Rating	Serviceable Range	Inrush ^{★2} (A)		Holding (A)		Power (W)	
						New	Current	New	Current	New	Current
Standard Type	AC ^{★1}	A100	50	100	80 - 110	2.42	2.38	0.51	0.46	—	—
			60	100	90 - 120	2.14	2.12	0.37	0.32		
				110		2.35	2.33	0.44	0.39		
		A120	50	120	96 - 132	2.02	1.98	0.42	0.38		
			60		108 - 144	1.78	1.77	0.31	0.27		
		Shockless Type	AC	A200	50	200	160 - 220	1.21	1.19		
60	180 - 240				1.07		1.06	0.19	0.16		
	A240			50	240	192 - 264	1.01	0.99	0.21	0.19	
60				216 - 288		0.89	0.89	0.15	0.13		
Shockless Type	DC	D12, D24, D48	—	12	10.8 - 13.2	—	—	2.45	2.2	29	26
				24	21.6 - 26.4			1.23	1.1		
				48	43.2 - 52.8			0.61	0.55		
Shockless Type	AC→DC Rectified	R100, R200	50/60	100	90 - 110	—	—	0.33	0.30	29	26
				200	180 - 220			0.16	0.15		

★ 1. Shockless type AC solenoids are not available.

★ 2. Inrush current in the above table shown rms values at maximum stroke.

- Interchangeability in Installation

- AC solenoids

There is an interchangeability in installation, except for differences in the dimensions with an star mark.

Current : Design 50

New : Design 60

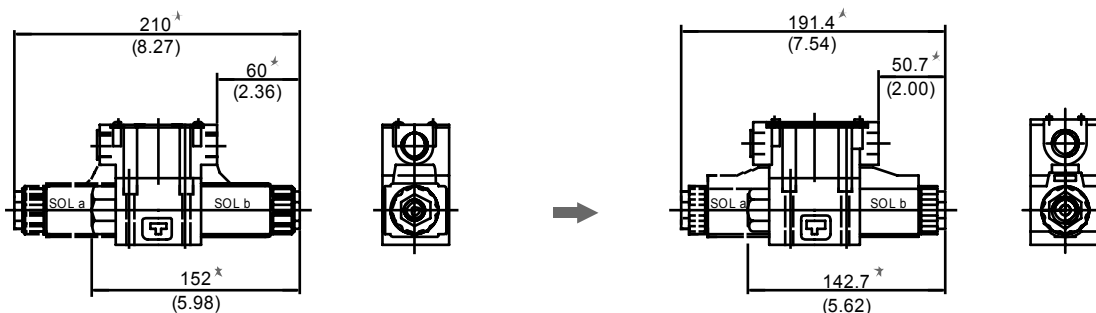

- DC/R Type solenoids

There is an interchangeability in installation, except for a solenoid shape changes from hexagonal to circular. There are no other changes in appearance, dimensions etc.